

骰子的秘密

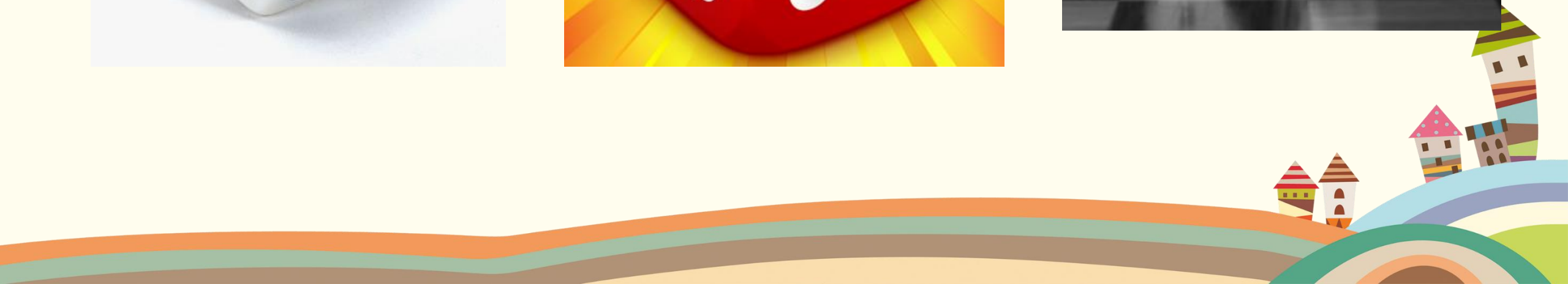

骰子



骰子



骰子 tóu zi

古代中国民间娱乐用品

投掷



骰子的秘密



骰子的秘密



这一面的点数是几？
那它的对面呢？



骰子的秘密



减运算

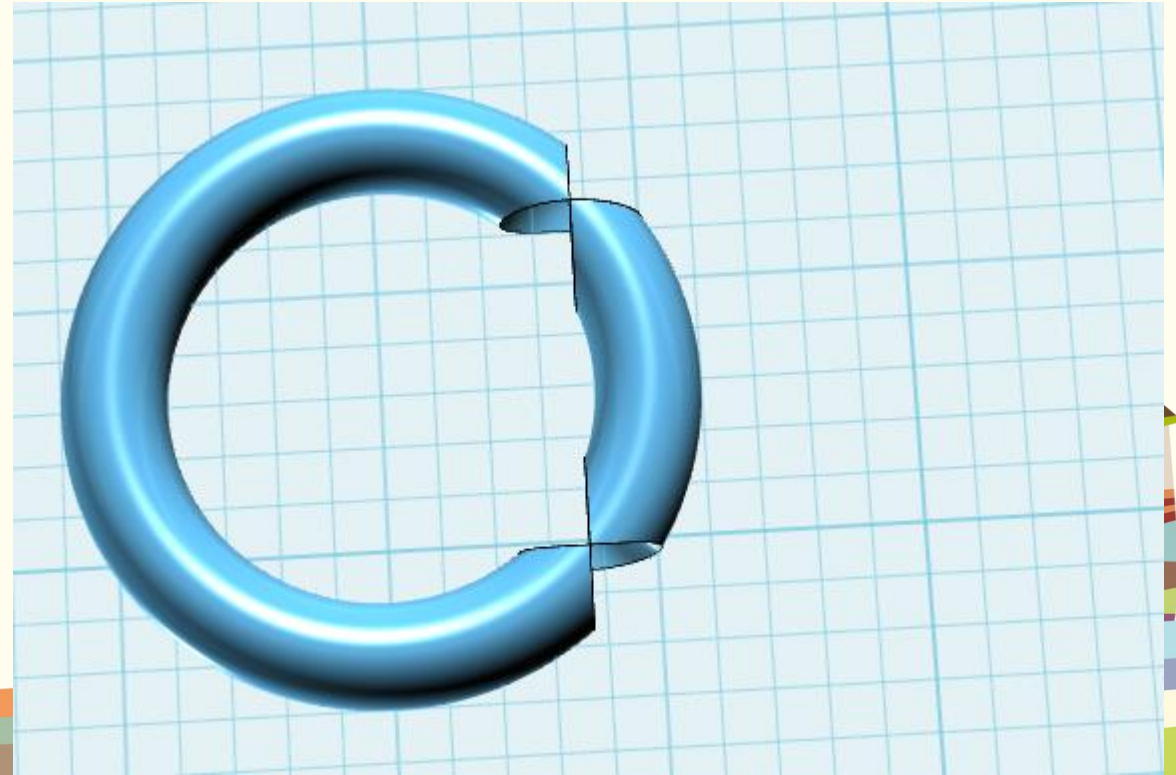
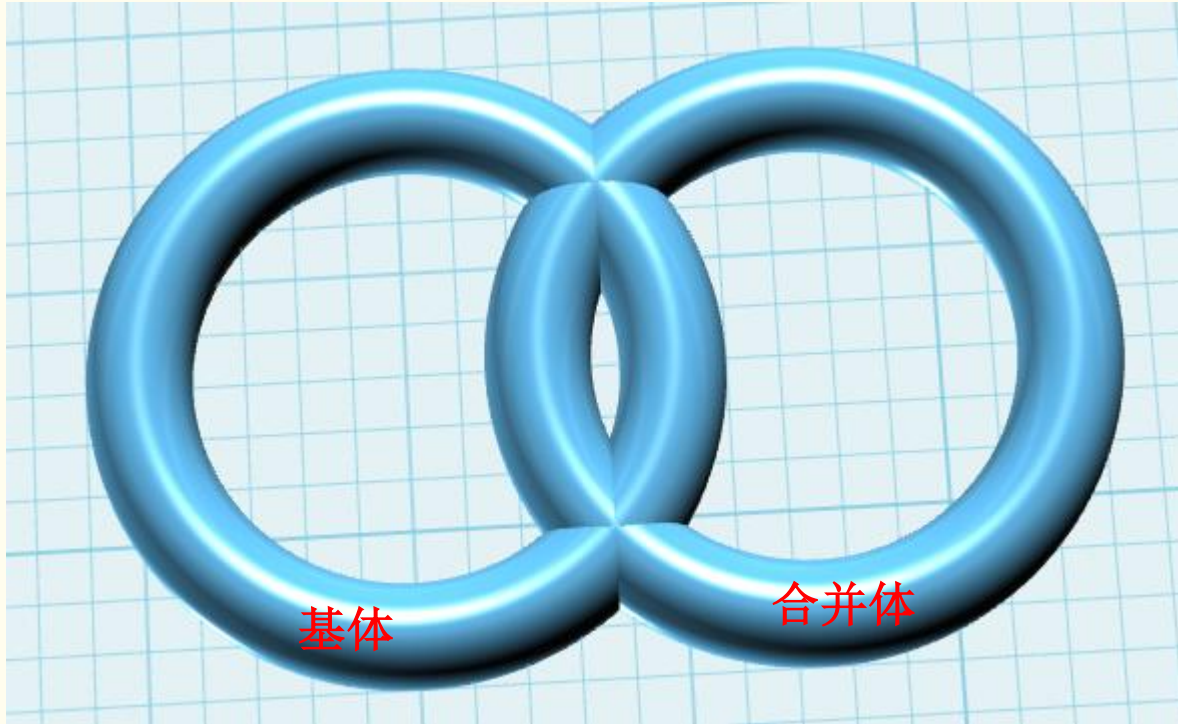

减运算

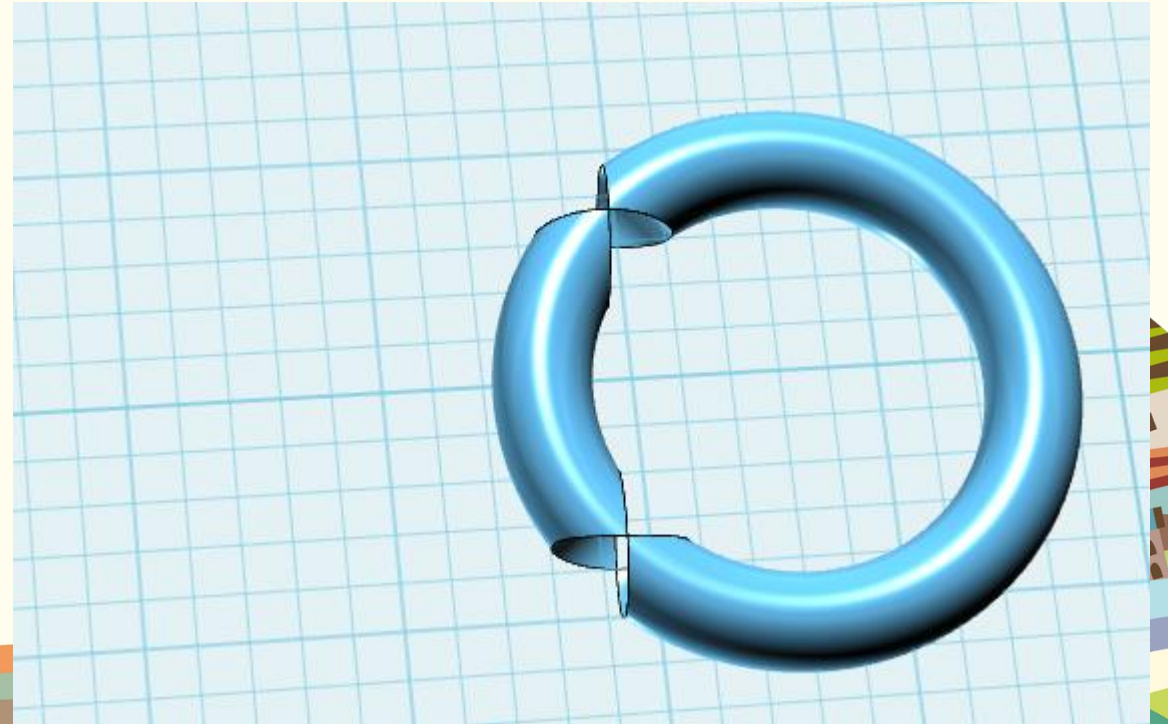
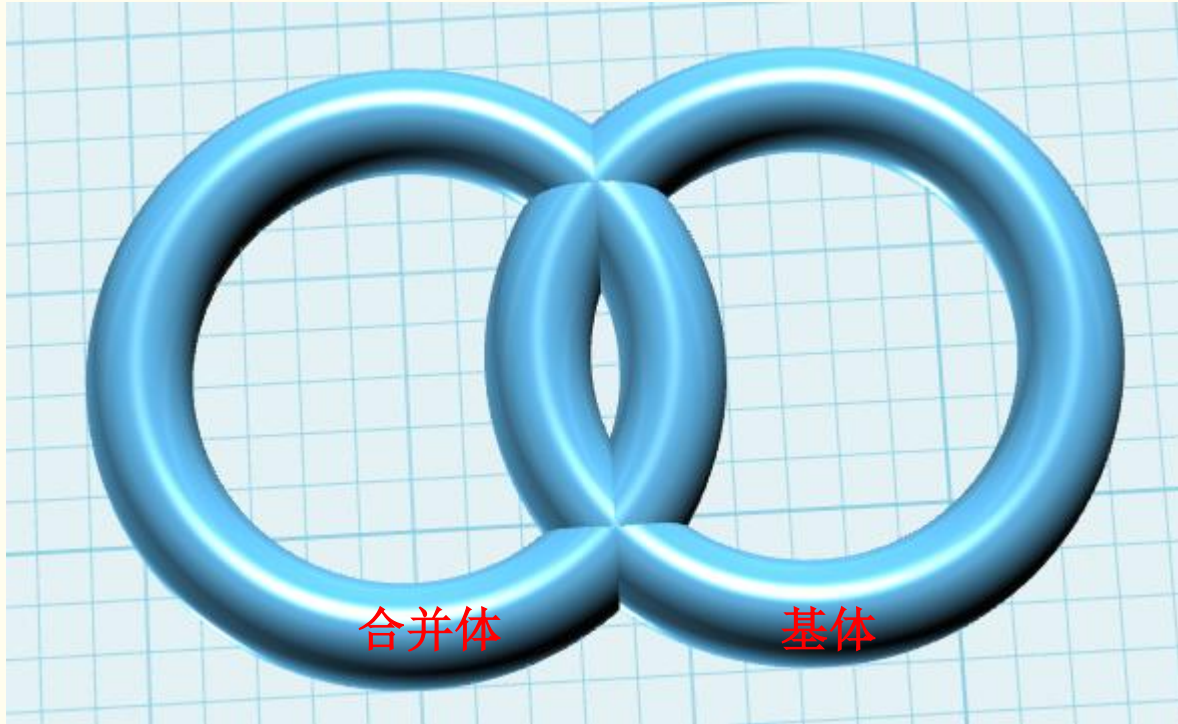

减运算

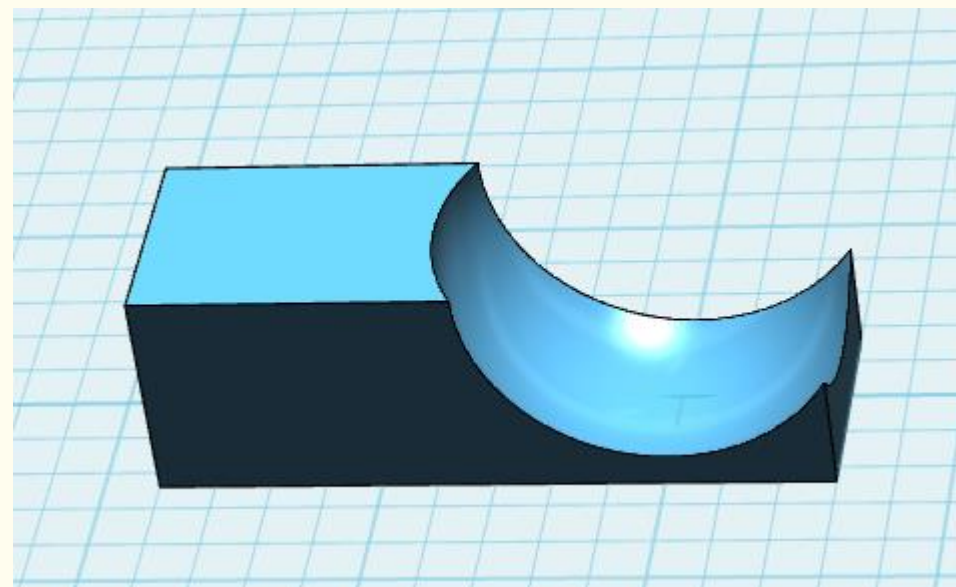
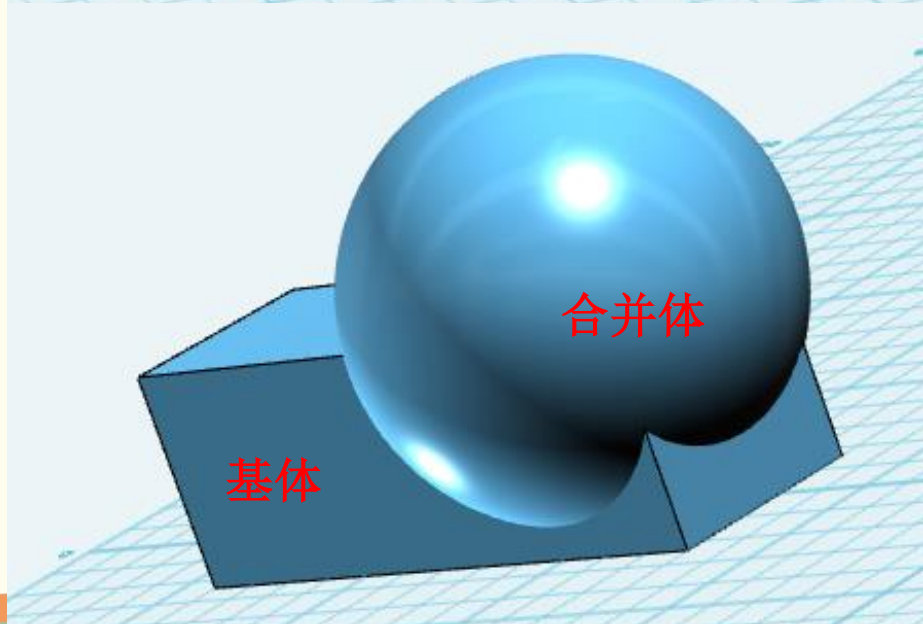
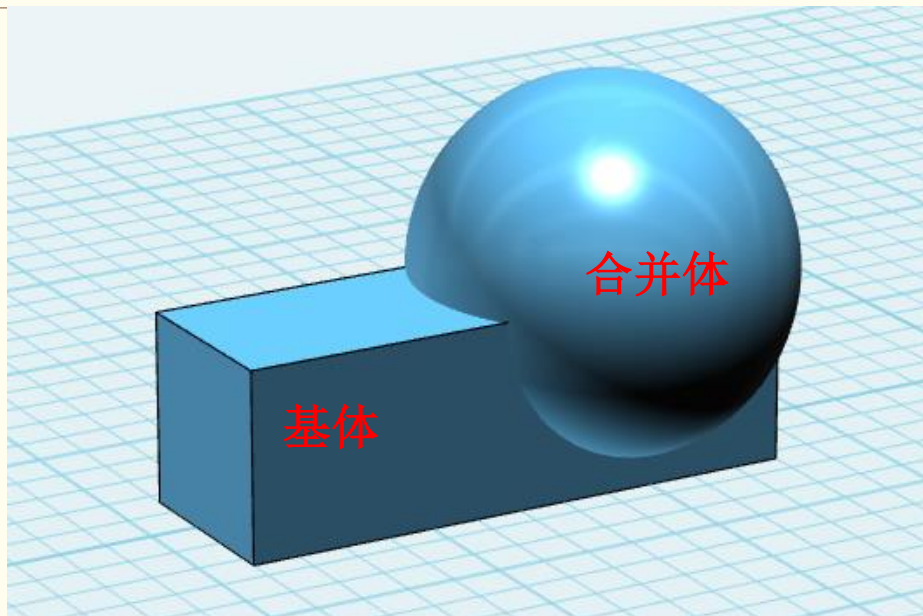

减运算

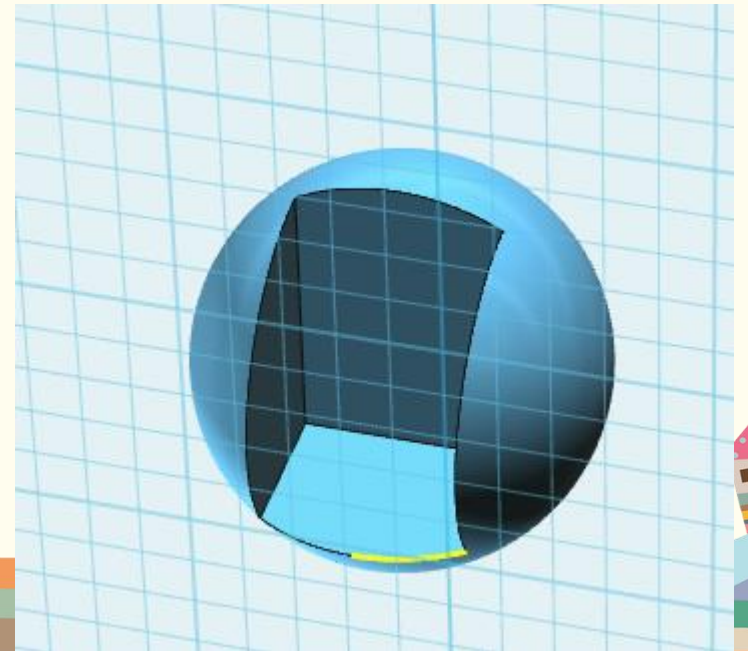
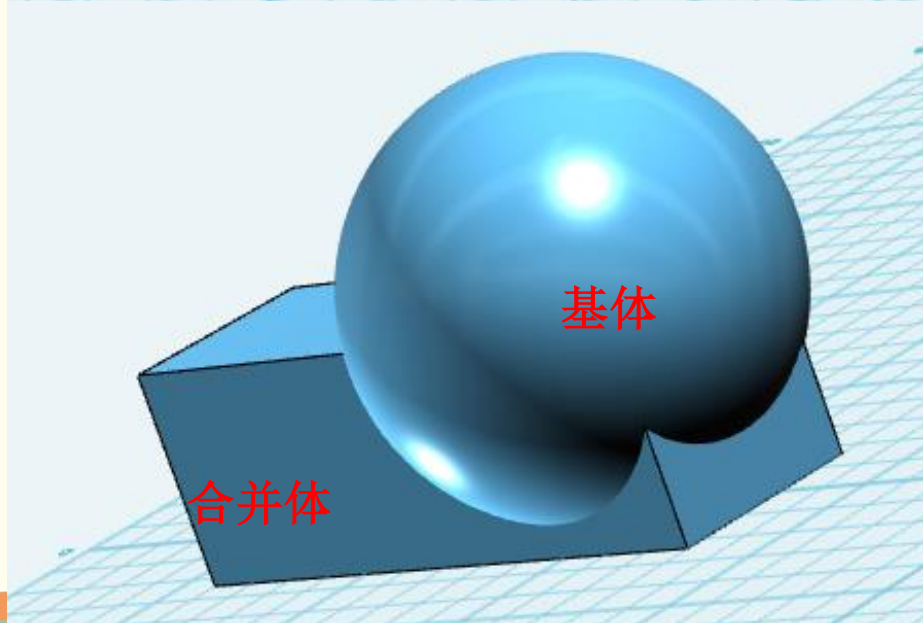
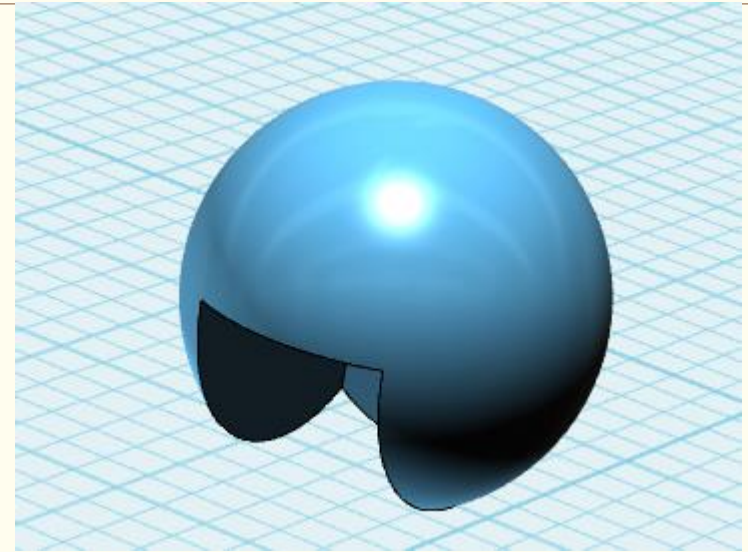
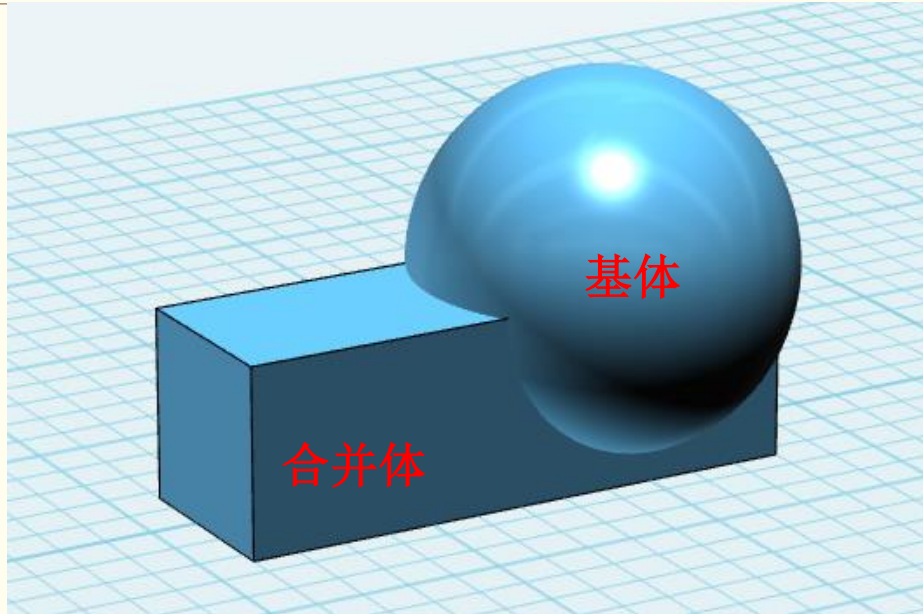

建模命令



视图命令

- 上
- 下
- 前
- 后
- 左
- 右

基本实体

- 球体

显示/隐藏

- 显示几何体
- 隐藏几何体

草图绘制

- 矩形

特征造型

- 拉伸

特殊功能

- 实体分割

基本编辑

- 阵列



建模

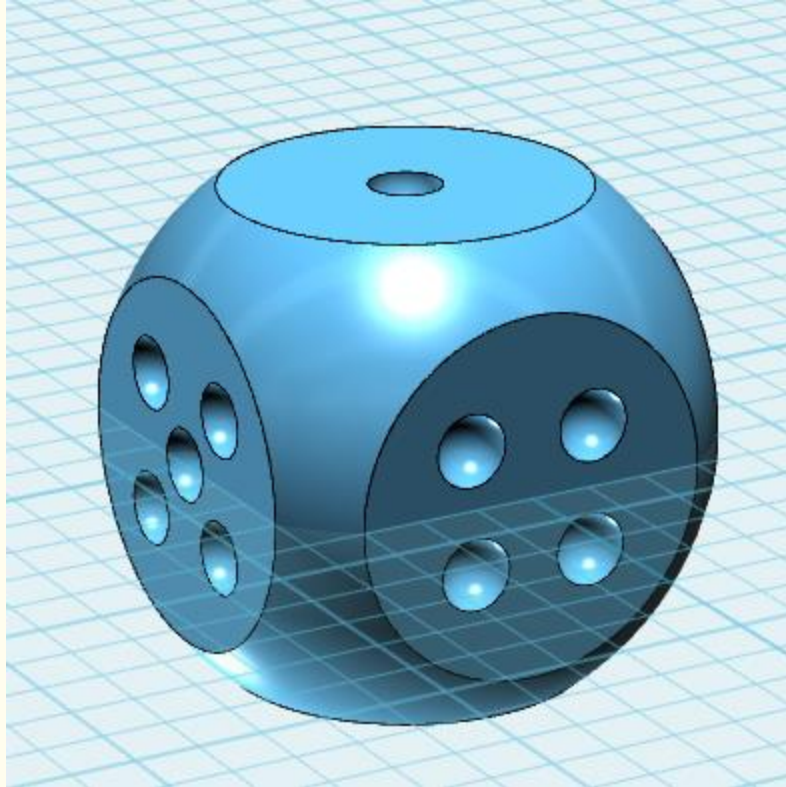

切片

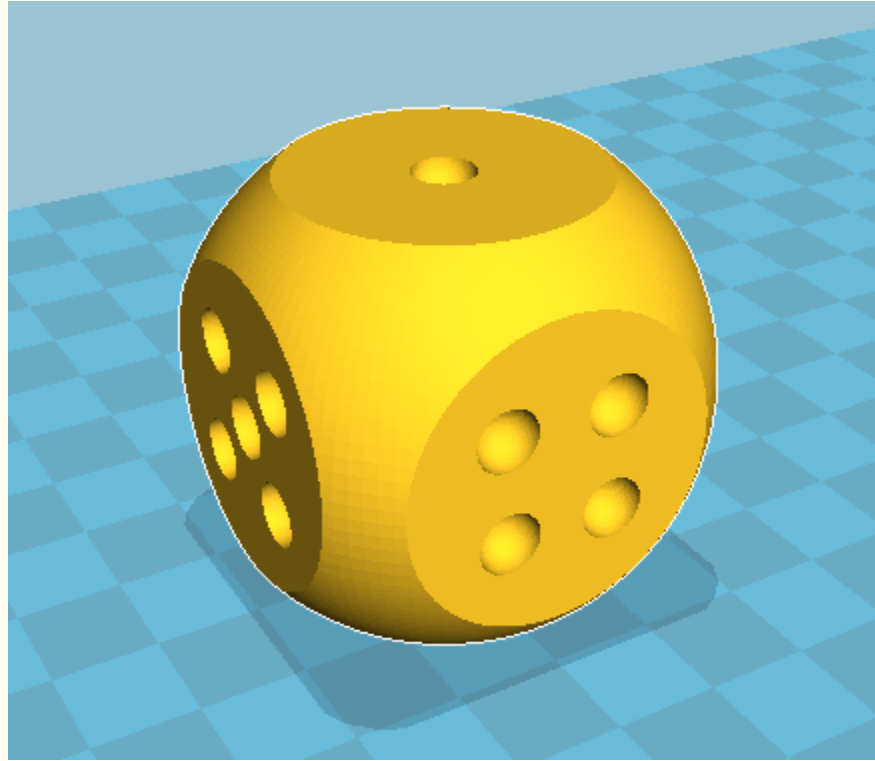

Thank you

